



Cisco Model DPC3939 DOCSIS 3.0
16x4 Wireless Residential Voice
Gateway
User Guide

Please Read

Important

Read this entire guide. If this guide provides installation or operation instructions, give particular attention to all safety statements included in this guide.

Notices

Trademark Acknowledgments

Cisco and the Cisco logo are trademarks or registered trademarks of Cisco and/or its affiliates in the U.S. and other countries. To view a list of Cisco trademarks, go to this URL: www.cisco.com/go/trademarks. DOCSIS is a registered trademark of Cable Television Laboratories, Inc. EuroDOCSIS, EuroPacketCable, and PacketCable are trademarks of Cable Television Laboratories, Inc. The Wi-Fi Protected Setup mark is a mark of the Wi-Fi Alliance. Wi-Fi Protected Setup is a trademark of the Wi-Fi Alliance.

Other third party trademarks mentioned are the property of their respective owners.

The use of the word partner does not imply a partnership relationship between Cisco and any other company. (1110R)

Publication Disclaimer

Cisco Systems, Inc. assumes no responsibility for errors or omissions that may appear in this publication. We reserve the right to change this publication at any time without notice. This document is not to be construed as conferring by implication, estoppel, or otherwise any license or right under any copyright or patent, whether or not the use of any information in this document employs an invention claimed in any existing or later issued patent.

Disclaimer

The maximum performance for wireless is derived from IEEE Standard 802.11 specifications. Actual performance can vary, including lower wireless network capacity, data throughput rate, range and coverage. Performance depends on many factors, conditions and variables, including distance from the access point, volume of network traffic, building materials and construction, operating system used, mix of wireless products used, interference and other adverse conditions.

Software and Firmware Use

The software described in this document is protected by copyright law and furnished to you under a license agreement. You may only use or copy this software in accordance with the terms of your license agreement.

The firmware in this equipment is protected by copyright law. You may only use the firmware in the equipment in which it is provided. Any reproduction or distribution of this firmware, or any portion of it, without our express written consent is prohibited.









Copyright

© 2013 Cisco Systems, Inc. All rights reserved.

Information in this publication is subject to change without notice. No part of this publication may be reproduced or transmitted in any form, by photocopy, microfilm, xerography, or any other means, or incorporated into any information retrieval system, electronic or mechanical, for any purpose, without the express permission of Cisco Systems, Inc.

Notice to Installers

The servicing instructions in this notice are for use by qualified service personnel only. To reduce the risk of electric shock, do not perform any servicing other than that contained in the operating instructions, unless you are qualified to do so.

<p>Note to System Installer</p> <p>For this apparatus, the coaxial cable shield/ screen shall be grounded as close as practical to the point of entry of the cable into the building. For products sold in the US and Canada, this reminder is provided to call the system installer's attention to Article 820-93 and Article 820-100 of the NEC (or Canadian Electrical Code Part 1), which provides guidelines for proper grounding of the coaxial cable shield.</p>	<table border="1"><tr><td></td><td>CAUTION RISK OF ELECTRIC SHOCK DO NOT OPEN</td><td></td></tr><tr><td></td><td>AVIS RISQUE DE CHOC ÉLECTRIQUE NE PAS OUVRIR</td><td></td></tr></table>		CAUTION RISK OF ELECTRIC SHOCK DO NOT OPEN			AVIS RISQUE DE CHOC ÉLECTRIQUE NE PAS OUVRIR	
	CAUTION RISK OF ELECTRIC SHOCK DO NOT OPEN						
	AVIS RISQUE DE CHOC ÉLECTRIQUE NE PAS OUVRIR						
 <p>This symbol is intended to alert you that uninsulated voltage within this product may have sufficient magnitude to cause electric shock. Therefore, it is dangerous to make any kind of contact with any inside part of this product.</p>	<p>CAUTION: To reduce the risk of electric shock, do not remove cover (or back). No user-serviceable parts inside. Refer servicing to qualified service personnel.</p> <p>WARNING TO PREVENT FIRE OR ELECTRIC SHOCK, DO NOT EXPOSE THIS UNIT TO RAIN OR MOISTURE.</p>  <p>This symbol is intended to alert you of the presence of important operating and maintenance (servicing) instructions in the literature accompanying this product.</p>						





Notice à l'attention des installateurs de réseaux câblés

Les instructions relatives aux interventions d'entretien, fournies dans la présente notice, s'adressent exclusivement au personnel technique qualifié. Pour réduire les risques de chocs électriques, n'effectuer aucune intervention autre que celles décrites dans le mode d'emploi et les instructions relatives au fonctionnement, à moins que vous ne soyez qualifié pour ce faire.

<p>Remarque à l'attention de l'installateur du système</p> <p>Avec cet appareil, le blindage/écran du câble coaxial doit être mis à la terre aussi près que possible du point d'entrée du câble dans le bâtiment. En ce qui concerne les produits vendus aux États-Unis et au Canada, ce rappel est fourni pour attirer l'attention de l'installateur sur les articles 820-93 et 820-100 du Code national de l'électricité (ou Code de l'électricité canadien, Partie 1) qui fournissent des lignes directrices concernant la mise à la terre correcte du blindage (écran) du câble coaxial.</p>	<table border="1"><tr><td></td><td>CAUTION RISK OF ELECTRIC SHOCK DO NOT OPEN</td><td></td></tr><tr><td></td><td>ATTENTION DANGER ÉLECTRIQUE NE PAS OUVRIR</td><td></td></tr></table>		CAUTION RISK OF ELECTRIC SHOCK DO NOT OPEN			ATTENTION DANGER ÉLECTRIQUE NE PAS OUVRIR	
	CAUTION RISK OF ELECTRIC SHOCK DO NOT OPEN						
	ATTENTION DANGER ÉLECTRIQUE NE PAS OUVRIR						
 <p>Ce symbole a pour but de vous prévenir que des tensions électriques non isolées existent à l'intérieur de ce produit, pouvant être d'une intensité suffisante pour causer des chocs électriques. Il est donc dangereux d'établir un contact quelconque avec l'une des pièces comprises à l'intérieur de ce produit.</p>	<p>ATTENTION : Pour réduire les risques de chocs électriques, ne pas enlever le couvercle (ou le panneau arrière). Ne contient aucune pièce réparable par l'utilisateur. Confier les interventions aux techniciens d'entretien qualifiés.</p> <p>AVERTISSEMENT POUR ÉVITER LES INCENDIES OU LES CHOC ÉLECTRIQUES, NE PAS EXPOSER L'APPAREIL À LA PLUIE OU À L'HUMIDITÉ.</p>  <p>Ce symbole a pour but de vous prévenir de la présence d'instructions importantes relatives au fonctionnement ou à l'entretien (et aux réparations) dans la documentation accompagnant ce produit.</p>						

Mitteilung für CATV-Techniker

Die in dieser Mitteilung aufgeführten Wartungsanweisungen sind ausschließlich für qualifiziertes Fachpersonal bestimmt. Um die Gefahr eines elektrischen Schlags zu reduzieren, sollten Sie keine Wartungsarbeiten durchführen, die nicht ausdrücklich in der Bedienungsanleitung aufgeführt sind, außer Sie sind zur Durchführung solcher Arbeiten qualifiziert.

<p>Mitteilung an den Systemtechniker</p> <p>Für dieses Gerät muss der Koaxialkabelschutz/ Schirm so nahe wie möglich am Eintrittspunkt des Kabels in das Gebäude geerdet werden. Dieser Erinnerungshinweis liegt den in den USA oder Kanada verkauften Produkten bei. Er soll den Systemtechniker auf Paragraph 820-93 und Paragraph 820-100 der US-Elektrovorschrift NEC (oder der kanadischen Elektrovorschrift Canadian Electrical Code Teil 1) aufmerksam machen, in denen die Richtlinien für die ordnungsgemäße Erdung des Koaxialkabelschirms festgehalten sind.</p>	 <table border="1"><tr><td>CAUTION</td></tr><tr><td>RISK OF ELECTRIC SHOCK DO NOT OPEN</td></tr><tr><td>ACHTUNG</td></tr><tr><td>STROMSCHLAGEGFAHR, NICHT ÖFFNEN</td></tr></table> 	CAUTION	RISK OF ELECTRIC SHOCK DO NOT OPEN	ACHTUNG	STROMSCHLAGEGFAHR, NICHT ÖFFNEN
CAUTION					
RISK OF ELECTRIC SHOCK DO NOT OPEN					
ACHTUNG					
STROMSCHLAGEGFAHR, NICHT ÖFFNEN					
 <p>Dieses Symbol weist den Benutzer auf das Vorhandensein von nicht isolierten gefährlichen Spannungen im Gerät hin, die Stromschläge verursachen können. Ein Kontakt mit den internen Teilen dieses Produktes ist mit Gefahren verbunden.</p>	<p>ACHTUNG: Zur Vermeidung eines Stromschlags darf die Abdeckung (bzw. die Geräterückwand) nicht entfernt werden. Das Gerät enthält keine vom Benutzer wartbaren Teile. Wartungsarbeiten dürfen nur von qualifiziertem Fachpersonal durchgeführt werden.</p> <p>WARNUNG</p> <p>DAS GERÄT NICHT REGEN ODER FEUCHTIGKEIT AUSSETZEN, UM STROMSCHLAG ODER DURCH EINEN KURZSCHLUSS VERURSACHTEN BRAND ZU VERMEIDEN.</p> 				
	<p>Dieses Symbol weist den Benutzer darauf hin, dass die mit diesem Produkt gelieferte Dokumentation wichtige Betriebs- und Wartungsanweisungen für das Gerät enthält.</p>				

Aviso a los instaladores de sistemas CATV

Las instrucciones de reparación contenidas en el presente aviso son para uso exclusivo por parte de personal de mantenimiento cualificado. Con el fin de reducir el riesgo de descarga eléctrica, no realice ninguna otra operación de reparación distinta a las contenidas en las instrucciones de funcionamiento, a menos que posea la cualificación necesaria para hacerlo.

<p>Nota para el instalador del sistema</p> <p>En lo que se refiere a este aparato, el blindaje del cable coaxial debe conectarse a tierra lo más cerca posible al punto por el cual el cable entra en el edificio. En el caso de los productos vendidos en los EE. UU. y Canadá, el presente aviso se suministra para llamar la atención del instalador del sistema sobre los Artículos 820-93 y 820-100 del NEC (o Código Eléctrico de Canadá, Parte 1), que proporcionan directrices para una correcta conexión a tierra del blindaje del cable coaxial.</p>	 <table border="1"><tr><td>CAUTION</td></tr><tr><td>RISK OF ELECTRIC SHOCK DO NOT OPEN</td></tr><tr><td>ATENCIÓN</td></tr><tr><td>RIESGO DE DESCARGA ELÉCTRICA NO ABRIR</td></tr></table> 	CAUTION	RISK OF ELECTRIC SHOCK DO NOT OPEN	ATENCIÓN	RIESGO DE DESCARGA ELÉCTRICA NO ABRIR
CAUTION					
RISK OF ELECTRIC SHOCK DO NOT OPEN					
ATENCIÓN					
RIESGO DE DESCARGA ELÉCTRICA NO ABRIR					
 <p>Este símbolo tiene como fin advertirle de que una tensión sin aislamiento en el interior de este producto podría ser de una magnitud suficiente como para provocar una descarga eléctrica. Por consiguiente, resulta peligroso realizar cualquier tipo de contacto con alguno de los componentes internos de este producto.</p>	<p>ATENCIÓN: con el fin de reducir el riesgo de descarga eléctrica, no retire la tapa (ni la parte posterior). No existen en el interior componentes que puedan ser reparados por el usuario. Encargue su revisión a personal de mantenimiento cualificado.</p> <p>ADVERTENCIA</p> <p>PARA EVITAR EL RIESGO DE INCENDIO O DESCARGA ELÉCTRICA, NO EXPONGA LA UNIDAD A LA LLUVIA O A LA HUMEDAD.</p> 				
	<p>Este símbolo tiene como fin alertarle de la presencia de importantes instrucciones de operación y mantenimiento (revisión) contenidas en la literatura que acompaña al producto.</p>				

Contents

IMPORTANT SAFETY INSTRUCTIONS	v
United States FCC Compliance	xi
CE Compliance	xiii
About This Guide	xv
Chapter 1 Introducing the Residential Gateway	1
Introduction	2
What's In the Carton?	4
Front Panel Description	5
Top Panel Description.....	7
Bottom Panel Description.....	8
Back Panel Description	9
Chapter 2 Installing the Residential Gateway	11
Installation Preparations	12
Install the Residential Gateway	17
Install the Battery	20
MoCA Installation Guidelines.....	22
Chapter 3 Configuring the Residential Gateway	25
Configure Wireless Settings	26
Chapter 4 Operation of Front Panel Indicators	37
Initial Power Up, Calibration, and Registration (AC Power applied).....	38
Normal Operations (AC Power Applied)	40
Special Conditions.....	41

Chapter 5 Maintaining the Battery	43
Location of the Battery	44
Battery Maintenance	45
Chapter 6 Troubleshooting the Residential Gateway	47
Frequently Asked Questions	48
Common Troubleshooting Issues	54
Tips for Improved Performance	56
Chapter 7 Customer Information	57

IMPORTANT SAFETY INSTRUCTIONS

- 1) Read these instructions.
- 2) Keep these instructions.
- 3) Heed all warnings.
- 4) Follow all instructions.
- 5) Do not use this apparatus near water.
- 6) Clean only with dry cloth.
- 7) Do not block any ventilation openings. Install in accordance with the manufacturer's instructions.
- 8) Do not install near any heat sources such as radiators, heat registers, stoves, or other apparatus (including amplifiers) that produce heat.
- 9) Do not defeat the safety purpose of the polarized or grounding-type plug. A polarized plug has two blades with one wider than the other. A grounding-type plug has two blades and a third grounding prong. The wide blade or the third prong is provided for your safety. If the provided plug does not fit into your outlet, consult an electrician for replacement of the obsolete outlet.
- 10) Protect the power cord from being walked on or pinched particularly at plugs, convenience receptacles, and the point where they exit from the apparatus.
- 11) Only use attachments/accessories specified by the manufacturer.
- 12)  Use only with the cart, stand, tripod, bracket, or table specified by the manufacturer, or sold with the apparatus. When a cart is used, use caution when moving the cart/apparatus combination to avoid injury from tip-over.
- 13) Unplug this apparatus during lightning storms or when unused for long periods of time.
- 14) Refer all servicing to qualified service personnel. Servicing is required when the apparatus has been damaged in any way, such as a power-supply cord or plug is damaged, liquid has been spilled or objects have fallen into the apparatus, the apparatus has been exposed to rain or moisture, does not operate normally, or has been dropped.

Power Source Warning

A label on this product indicates the correct power source for this product. Operate this product only from an electrical outlet with the voltage and frequency indicated on the product label. If you are uncertain of the type of power supply to your home or business, consult your service provider or your local power company.

The AC inlet on the unit must remain accessible and operable at all times.

Ground the Product



WARNING: Avoid electric shock and fire hazard! If this product connects to coaxial cable wiring, be sure the cable system is grounded (earthed). Grounding provides some protection against voltage surges and built-up static charges.

IMPORTANT SAFETY INSTRUCTIONS

Outdoor Grounding System

If this product connects to an outdoor antenna or cable system, be sure the antenna or cable system is grounded (earthed). This provides some protection against voltage surges and built-up static charges.

Article 810 of the National Electric Code (NEC) ANSI/NFPA No. 70-1990, provides the following information:

- Grounding of the mast and supporting structure
- Grounding the lead-in wire to an antenna discharge unit
- Size of the grounding conductors
- Location of the antenna-discharge unit
- Connection to grounding electrodes
- Requirements for the grounding electrodes (see the following antenna grounding diagram as recommended by NEC ANSI/NFPA 70)



WARNING: Avoid electric shock and fire hazard! Do not locate an outside antenna system in the vicinity of overhead power lines or power circuits. Touching power lines or circuits might be fatal.

Example Of Antenna Grounding

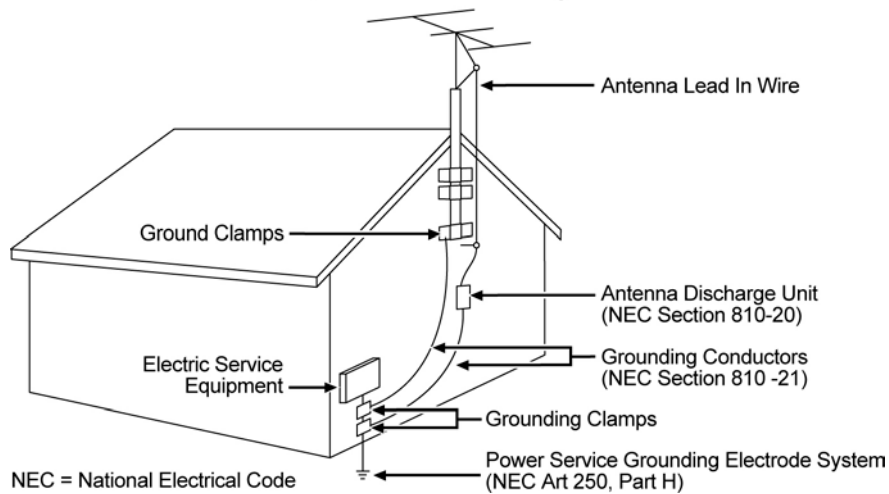

Protect the Product from Lightning

In addition to disconnecting the AC power from the wall outlet, disconnect the signal inputs.

Verify the Power Source from the On/Off Power Light

When the on/off power light is not illuminated, the apparatus may still be connected to the power source. The light may go out when the apparatus is turned off, regardless of whether it is still plugged into an AC power source.

Eliminate AC Power/Mains Overloads



WARNING: Avoid electric shock and fire hazard! Do not overload AC power/mains, outlets, extension cords, or integral convenience receptacles. For products that require battery power or other power sources to operate them, refer to the operating instructions for those products.

Handling Disposable Batteries

This product may contain a rechargeable Lithium-Ion battery to provide stand-by operation in the event of an AC power failure.

Heed the following warning, follow the Battery Safety and Battery Disposal instructions below, and see the instructions later in this guide for handling, replacing, and disposing of the battery.



WARNING: There is danger of explosion if the battery is mishandled or incorrectly replaced. Replace only with the same type of battery. Do not disassemble it or attempt to recharge it outside the system. Do not crush, puncture, dispose of in fire, short the external contacts, or expose to water or other liquids. Dispose of the battery in accordance with local regulations and instructions from your service provider.

Battery Safety

- Insert batteries correctly. There may be a risk of explosion if the batteries are incorrectly inserted.
- Do not attempt to recharge ‘disposable’ or ‘non-reusable’ batteries.
- Please follow instructions provided for charging ‘rechargeable’ batteries.
- Replace batteries with the same or equivalent type that we recommend.
- Do not expose batteries to excessive heat (such as sunlight or fire).
- Do not expose batteries to temperatures above 100°C (212°F).

Battery Disposal

- The batteries may contain substances that could be harmful to the environment.
- Recycle or dispose of batteries in accordance with the battery manufacturer’s instructions and local/national disposal and recycling regulations.



廢電池請回收

- The batteries may contain perchlorate, a known hazardous substance, so special handling and disposal of this product might be necessary. For more information about perchlorate and best management practices for perchlorate-containing substance, see www.dtsc.ca.gov/hazardouswaste/perchlorate

Provide Ventilation and Select a Location

- Remove all packaging material before applying power to the product.
- Make certain to operate this unit only in a vertical position.
- Do not place this apparatus on a bed, sofa, rug, or similar surface.
- Do not place this apparatus on an unstable surface.

IMPORTANT SAFETY INSTRUCTIONS

- Do not install this apparatus in an enclosure, such as a bookcase or rack, unless the installation provides proper ventilation.
- Do not place entertainment devices (such as VCRs or DVDs), lamps, books, vases with liquids, or other objects on top of this product.
- Do not block ventilation openings.

Operating Environment

This product is designed for operation indoors with a temperature range from 32° to 104° F (0° to 40°C). Each product should have adequate spacing on all sides so that the cooling air vents on the chassis are not blocked.

Protect from Exposure to Moisture and Foreign Objects



WARNING: Avoid electric shock and fire hazard! Do not expose this product to dripping or splashing liquids, rain, or moisture. Objects filled with liquids, such as vases, should not be placed on this apparatus.



WARNING: Avoid electric shock and fire hazard! Unplug this product before cleaning. Do not use a liquid cleaner or an aerosol cleaner. Do not use a magnetic/static cleaning device (dust remover) to clean this product.



WARNING: Avoid electric shock and fire hazard! Never push objects through the openings in this product. Foreign objects can cause electrical shorts that can result in electric shock or fire.

Service Warnings



WARNING: Avoid electric shock! Do not open the cover of this product. Opening or removing the cover may expose you to dangerous voltages. If you open the cover, your warranty will be void. This product contains no user-serviceable parts.

Check Product Safety

Upon completion of any service or repairs to this product, the service technician must perform safety checks to determine that this product is in proper operating condition.

Protect the Product When Moving It

Always disconnect the power source when moving the apparatus or connecting or disconnecting cables.

Telephone Equipment Notice

When using your telephone equipment, basic safety precautions should always be followed to reduce the risk of fire, electric shock and injury to persons, including the following:

1. Do not use this product near water, for example, near a bath tub, wash bowl, kitchen sink or laundry tub, in a wet basement or near a swimming pool.
2. Avoid using a telephone (other than a cordless type) during an electrical storm. There may be a remote risk of electric shock from lightning.
3. Do not use the telephone to report a gas leak in the vicinity of the leak.

Important: Interconnected telecommunication terminal equipment (for example via RJ11) must be UL listed and the connections must be made in accordance with Article 800 of the NEC



CAUTION: To reduce the risk of fire, use only No. 26 AWG or larger telecommunication line cord.

SAVE THESE INSTRUCTIONS

20110316_Cable_Safety

20110316_ModemNo Battery_Safety

20110316_Modemwith Battery_Safety

20110316_ModemDSL_Safety

United States FCC Compliance

This device has been tested and found to comply with the limits for a Class B digital device, pursuant to part 15 of the FCC Rules. These limits are designed to provide reasonable protection against such interference in a residential installation. This equipment generates, uses, and can radiate radio frequency energy. If not installed and used in accordance with the instructions, it may cause harmful interference to radio communications. However, there is no guarantee that interference will not occur in a particular installation. If this equipment does cause harmful interference to radio or television reception, which can be determined by turning the equipment OFF and ON, the user is encouraged to try to correct the interference by one or more of the following measures:

- Reorient or relocate the receiving antenna.
- Increase the separation between the equipment and receiver.
- Connect the equipment into an outlet on a circuit different from that to which the receiver is connected.
- Consult the service provider or an experienced radio/television technician for help.

Any changes or modifications not expressly approved by Cisco Systems, Inc., could void the user's authority to operate the equipment.

The information shown in the FCC Declaration of Conformity paragraph below is a requirement of the FCC and is intended to supply you with information regarding the FCC approval of this device. *The phone numbers listed are for FCC-related questions only and not intended for questions regarding the connection or operation for this device. Please contact your service provider for any questions you may have regarding the operation or installation of this device.*

FC Declaration of Conformity

This device complies with Part 15 of FCC Rules. Operation is subject to the following two conditions: 1) the device may not cause harmful interference, and 2) the device must accept any interference received, including interference that may cause undesired operation.

Residential Gateway Model(s): DPC3939 Manufactured by: Cisco Systems, Inc. 5030 Sugarloaf Parkway Lawrenceville, Georgia 30044 USA

Canada EMI Regulation

This Class B digital apparatus complies with Canadian ICES-003.

Cet appareil numérique de la class B est conforme à la norme NMB-003 du Canada.

RF Exposure Statements

Note: This transmitter must not be co-located or operated in conjunction with any other antenna or transmitter. This equipment should be installed and operated with a minimum distance of 7.9 inches (20 cm) between the radiator and your body. For products available in the USA/Canada market, only channels 1-11 can be operated. The selection of other channels is not possible.

US

This system has been evaluated for RF exposure for humans in reference to ANSI C 95.1 (American National Standards Institute) limits. The evaluation was based in accordance with FCC OET Bulletin 65C rev 01.01 in compliance with Part 2.1091 and Part 15.27. The minimum separation distance from the antenna to general bystander is 7.9 inches (20 cm) to maintain compliance.

Canada

This system has been evaluated for RF exposure for humans in reference to Canada Health Code 6 (2009) limits. The evaluation was based on evaluation per RSS-102 Rev 4. The minimum separation distance from the antenna to general bystander is 7.9 inches (20 cm) to maintain compliance.

20100527 FCCDSL_Domestic

CE Compliance

Declaration of Conformity with Regard to the EU Directive 1999/5/EC (R&TTE Directive)

This declaration is only valid for configurations (combinations of software, firmware and hardware) supported or provided by Cisco Systems for use within the EU. The use of software or firmware not supported or provided by Cisco Systems may result in the equipment no longer being compliant with the regulatory requirements.

Български [Bulgarian]:	Това оборудване отговаря на съществените изисквания и приложими клаузи на Директива 1999/5/EC.
Česky [Czech]:	Toto zařízení je v souladu se základními požadavky a ostatními odpovídajícími ustanoveními Směrnice 1999/5/EC.
Dansk [Danish]:	Dette udstyr er i overensstemmelse med de væsentlige krav og andre relevante bestemmelser i Direktiv 1999/5/EF.
Deutsch [German]:	Dieses Gerät entspricht den grundlegenden Anforderungen und den weiteren entsprechenden Vorgaben der Richtlinie 1999/5/EU.
Eesti [Estonian]:	See seade vastab direktiivi 1999/5/EU olulistele nõuetele ja teistele asjakohastele sätetele.
English:	This equipment is in compliance with the essential requirements and other relevant provisions of Directive 1999/5/EC.
Español [Spanish]:	Este equipo cumple con los requisitos esenciales así como con otras disposiciones de la Directiva 1999/5/CE.
Ελληνική [Greek]:	Αυτός ο εξοπλισμός είναι σε συμμόρφωση με τις ουσιαστικές απαιτήσεις και άλλες σχετικές διατάξεις της Οδηγίας 1999/5/EC.
Français [French]:	Cet appareil est conforme aux exigences essentielles et aux autres dispositions pertinentes de la Directive 1999/5/EC.
Íslenska [Icelandic]:	Þetta tæki er samkvæmt grunnkröfum og öðrum viðeigandi ákvæðum Tilskipunar 1999/5/EC.
Italiano [Italian]:	Questo apparato è conforme ai requisiti essenziali ed agli altri principi sanciti dalla Direttiva 1999/5/CE.
Latviski [Latvian]:	Šī iekārta atbilst Direktīvas 1999/5/EK būtiskajām prasībām un citiem ar to saistītajiem noteikumiem.
Lietuvių [Lithuanian]:	Šis įrenginys tenkina 1999/5/EB Direktyvos esminius reikalavimus ir kitas šios direktyvos nuostatas.
Nederlands [Dutch]:	Dit apparaat voldoet aan de essentiële eisen en andere van toepassing zijnde bepalingen van de Richtlijn 1999/5/EC.
Malti [Maltese]:	Dan l-apparat huwa konformi mal-ftigiet essenzjali u l-provedimenti l-oħra rilevanti tad-Direttiva 1999/5/EC.
Magyar [Hungarian]:	Ez a készülék teljesíti az alapvető követelményeket és más 1999/5/EK irányelvben meghatározott vonatkozó rendelkezéseket.
Norsk [Norwegian]:	Dette utstyret er i samsvar med de grunnleggende krav og andre relevante bestemmelser i EU-direktiv 1999/5/EF.
Polski [Polish]:	Urządzenie jest zgodne z ogólnymi wymaganiami oraz szczególnymi warunkami określonymi Dyrektywą UE: 1999/5/EC.
Português [Portuguese]:	Este equipamento está em conformidade com os requisitos essenciais e outras provisões relevantes da Directiva 1999/5/EC.
Română [Romanian]:	Acest echipament este în conformitate cu cerințele esențiale și cu alte prevederi relevante ale Directivei 1999/5/EC.
Slovensko [Slovenian]:	Ta naprava je skladna z bistvenimi zahtevami in ostalimi relevantnimi pogoji Direktive 1999/5/EC.
Slovensky [Slovak]:	Toto zariadenie je v zhode so základnými požiadavkami a inými príslušnými nariadeniami direktív: 1999/5/EC.
Suomi [Finnish]:	Tämä laite täyttää direktiivin 1999/5/EY olennaiset vaatimukset ja on siinä asetettujen muiden laitetta koskevien määräysten mukainen.
Svenska [Swedish]:	Denna utrustning är i överensstämmelse med de väsentliga kraven och andra relevanta bestämmelser i Direktiv 1999/5/EC.

CE Compliance

Note: The full declaration of conformity for this product can be found at http://www.cisco.com/web/consumer/support/compliance_info.html.

The following standards were applied during the assessment of the product against the requirements of the Directive 1999/5/EC:

- Radio: EN 300 328
- EMC: EN 301 489-1 and EN 301 489-17
- Safety: EN 60950 and EN 50385

The CE mark and class-2 identifier are affixed to the product and its packaging. This product conforms to the following European directives:



National Restrictions

This product is for indoor use only.

France

For 2.4 GHz, the output power is restricted to 10 mW EIRP when the product is used outdoors in the band 2454 - 2483.5 MHz. There are no restrictions when used in other parts of the 2.4 GHz band. Check <http://www.arcep.fr/> for more details.

Pour la bande 2,4 GHz, la puissance est limitée à 10 mW en p.i.r.e. pour les équipements utilisés en extérieur dans la bande 2454 - 2483,5 MHz. Il n'y a pas de restrictions pour des utilisations dans d'autres parties de la bande 2,4 GHz. Consultez <http://www.arcep.fr/> pour de plus amples détails.

Italy

This product meets the National Radio Interface and the requirements specified in the National Frequency Allocation Table for Italy. Unless this wireless LAN product is operating within the boundaries of the owner's property, its use requires a "general authorization." Please check <http://www.comunicazioni.it/it/> for more details.

Questo prodotto è conforme alle specifiche di Interfaccia Radio Nazionali e rispetta il Piano Nazionale di ripartizione delle frequenze in Italia. Se non viene installato all'interno del proprio fondo, l'utilizzo di prodotti Wireless LAN richiede una "Autorizzazione Generale". Consultare <http://www.comunicazioni.it/it/> per maggiori dettagli.

Latvia

The outdoor usage of the 2.4 GHz band requires an authorization from the Electronic Communications Office. Please check <http://www.esd.lv> for more details.

2,4 GHz frekvenču joslas izmantošanai ārpus telpām nepieciešama atļauja no Elektronisko sakaru direkcijas. Vairāk informācijas: <http://www.esd.lv>.

Note: The regulatory limits for maximum output power are specified in EIRP. The EIRP level of a device can be calculated by adding the gain of the antenna used (specified in dBi) to the output power available at the connector (specified in dBm).

20110311_CE_Gateway

About This Guide

Introduction

Welcome. This guide provides instructions and recommendations for placing, installing, configuring, operating, maintaining, and troubleshooting the Cisco® Model DPC3939 DOCSIS 3.0 16x4 Wireless Residential Voice Gateway (DPC3939).

Purpose

This guide covers the Model DPC3939 DOCSIS 3.0 16x4 Wireless Residential Voice Gateway. All features described in this guide are standard to this Residential Gateway unless otherwise noted as an optional feature.

Audience

This guide is written for the home subscriber.

Document Version

This is the second release of this document. In addition to minor editorial changes, this release adds the default MoCA username and password.

1

Introducing the Residential Gateway

Introduction

This chapter provides an overview of Residential Gateway features, indicators, and connectors to help you become familiar with the Residential Gateway and the benefits it offers. This chapter also lists the accessories and equipment that are provided with the Residential Gateway so you can verify that you received all of these items.

In This Chapter

■ Introduction	2
■ What's In the Carton?	4
■ Front Panel Description	5
■ Top Panel Description.....	7
■ Bottom Panel Description.....	8
■ Back Panel Description	9

Introduction

The Cisco® Model DPC3939 DOCSIS 3.0 16x4 Wireless Residential Voice Gateway (DPC3939) is an advanced, high-performance home gateway that combines Ethernet, Voice over IP (VoIP), router, and wireless access point technologies in a single device to provide a cost-effective voice and networking solution for Connected Home and Managed Home experiences.

This chapter lists the benefits and features of the model DPC3939 Residential Gateway. Illustrations and descriptions of the connection ports, buttons, and LED indicators are also provided.

Benefits and Features

Your new Residential Gateway offers the following outstanding benefits and features.

DOCSIS

- Eight bonded downstream channels with a total throughput in excess of 300 Mbps
- Compliant with DOCSIS 3.0, 2.0, 1.1, and 1.0 standards to deliver high-end performance and reliability
- Enhanced packet processing technology to maximize performance

Connections

- Multimedia over Coax Alliance (MoCA) networking over coaxial cable in the home
- Four 10/100/1000BASE-T Ethernet ports to provide wired connectivity
- High-performance broadband Internet connectivity to energize your online experience
- Two ATA Ports with SIP Client support
- Supports separate phone numbers on each port
- Dual universal serial bus (USB) host support (contact your service provider for more information)
- WPS, including a push-button switch to activate WPS for simplified and secure wireless setup

Design and Function

- Embedded network management client for simplified out of the box setup and configuration
- Local device management via web-based GUI

Management

User-configurable Parental Control blocks access to undesirable Internet sites

- Simplified, unified home network management
- Advanced firewall technology deters hackers and protects the home network from unauthorized access
- Allows automatic software upgrades by your service provider
- DOCSIS-compliant secure software downloads

What's In the Carton?

When you receive your Residential Gateway, you should check the equipment and accessories to verify that each item is in the carton and that each item is undamaged. The carton contains the following items:



One Model DPC3939 Residential Gateway



One AC power cord



One Lithium Ion cartridge battery
(May not be provided with all products.)

If any of these items are missing or damaged, please contact your service provider for assistance.

Notes:

- A battery is needed only when voice service is enabled on the Residential Gateway.
- You need an optional cable signal splitter and additional standard RF coaxial cables if you want to connect a VCR, a Digital Home Communications Terminal (DHCT) or a set-top converter, or a TV to the same cable connection as your Residential Gateway.
- If your product supports telephone service, cables and other equipment needed for telephone service must be purchased separately. Contact your service provider to inquire about the equipment and cables you need for telephone service.

Front Panel Description

The front panel of your Residential Gateway provides LED status indicators that indicate how well and at what state your Residential Gateway is operating. See *Operation of Front Panel Indicators* (on page 37), for more information on front panel LED status indicator functions.

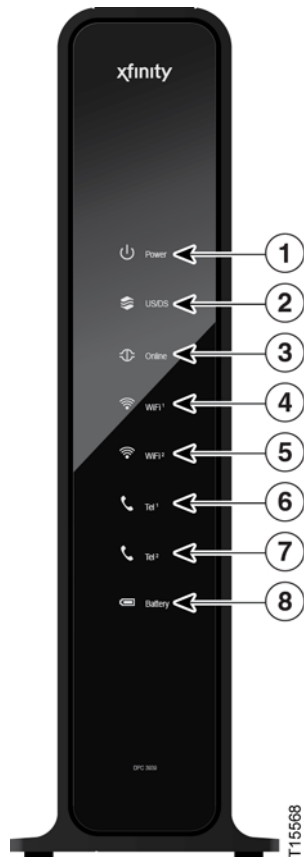

Residential Gateway

- 1 **POWER**—ON, power is applied to the Residential Gateway. OFF when power is off to the Residential Gateway.
- 2 **US/DS**—ON, the Residential Gateway is exchanging data with the cable network. Blinking indicates the downstream scan is in progress.
- 3 **ONLINE**—ON, the Residential Gateway is registered on the network and fully operational. OFF indicates the Residential Gateway has not registered on the network.
- 4 **2.4 GHz**—ON, the wireless access point is operational. Blinking indicates that data is being transferred over the wireless connection. OFF indicates that the wireless access point is not enabled.

- 5 **5 GHz**—ON, the wireless access point is operational. Blinking indicates that data is being transferred over the wireless connection. OFF indicates that the wireless access point is not enabled.
- 6 **TEL¹**—ON indicates telephony service is enabled. Blinks when line 1 is in use. OFF indicates that phone service for TEL 1 is not enabled.
- 7 **TEL²**—ON indicates telephony service is enabled. Blinks when line 2 is in use. OFF indicates that phone service for TEL 2 is not enabled.
- 8 **BATTERY (optional model only)**—ON indicates that the battery is charged. Blinking indicates that the battery charge is low. OFF indicates the unit is operating from battery power, the battery charge is depleted, or the battery is defective or missing.

Notes:

- After the Residential Gateway is successfully registered on the network, the POWER, US/DS, and ONLINE LEDs illuminate continuously to indicate that the Residential Gateway is active and fully operational.
- The high-speed data operation is disabled when operating on battery power; only the telephone service (if available on this model) is active when operating on battery power.
- LEDs may behave differently when the Residential Gateway is running on battery power (without AC power). Most LEDs are disabled if the unit is operating on battery power. In this mode, the POWER LED blinks to indicate that the unit is operating under battery power.
- The Residential Gateway should only run on battery power when AC power has failed. If the POWER LED indicates that the unit is running on battery power, but the AC power has not failed, verify that the power cord is plugged into a working AC outlet.

Top Panel Description

Two buttons and LEDs on the top panel of the Residential Gateway show the status of the Wireless Protected Setup (WPS) and Page features.



- 1 **WPS (WIRELESS PROTECTED SETUP)**—OFF (normal condition) Wireless Protected Setup is not active. Blinking indicates the button has been pressed and WPS is active so that a new wireless client can be added to the wireless network.
- 2 **PAGE**—OFF (normal condition) indicates the Page feature is not active. Slow blinking indicates the unit is on and communicating with registered telephone receivers (only CAT-iq 2.0 handsets). Fast blinking indicates that the unit is transmitting data to registered handsets. To register the unit with a handset, press the button for 15 seconds. After the unit and handset have registered, press the button for up to 3 seconds to page registered handsets; press the button again for up to 3 seconds to stop paging registered handsets.

Important: Use the Page feature only with Cordless Advanced Technology (CAT-iq 2.0 handsets). To learn more about CAT-iq 2.0 handsets, contact your service provider.

Bottom Panel Description

The bottom panel of your Residential Gateway contains a product information label and the door to the battery compartment.

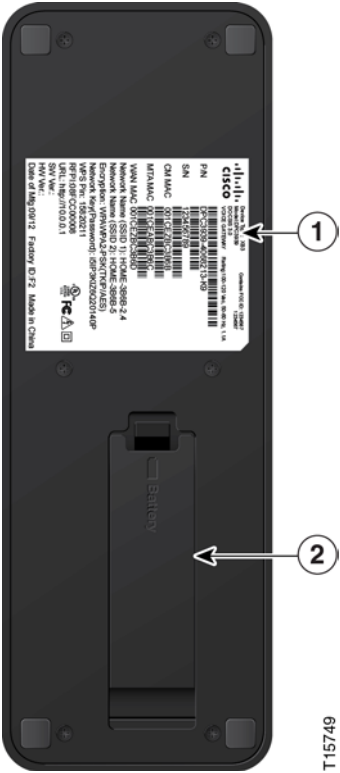

- 1 LABEL – product information label
- 2 BATTERY – battery compartment door

Back Panel Description

The following illustration identifies the back panel components on the Cisco Residential Gateway. Descriptions for each component follow the illustration.

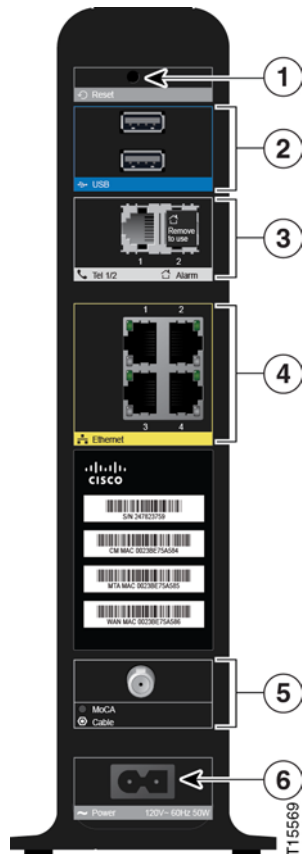

Important: Do not connect your PC to both the Ethernet and USB ports (future capability) at the same time.

Important: Use only the power cord provided with your Residential Gateway.

CAUTION:

Avoid damage to your equipment. Only use the power cord that is provided with your Residential Gateway.

- 1 RESET**—A momentary pressing (1-2 seconds) of this switch restarts the device. To press this switch, insert a thin object, such as a paper clip, into the RESET port; then press and hold the switch for more than ten seconds to reset all settings to their factory-settings and then restart the device.



CAUTION:

The RESET button is for maintenance purposes only. Do not use unless instructed to do so by your service provider. Doing so may cause you to lose any settings you have selected.

- 2 **USB** (optional for some models) – Connects the Residential Gateway to selected devices. For models that support USB, the default is one USB port.
- 3 **TEL1 and Alarm/Tel2** – RJ-11 telephone ports for connecting telephones, fax machines, and/or an analog home alarm system.
- 4 **ETHERNET** – Four RJ-45 Ethernet ports allow connection to the Ethernet port on your PC or network device.
- 5 **MoCA/Cable** – F-connector connects to your home coax network to provide Cable and MoCA service.
- 6 **POWER** – Connects the Residential Gateway to the AC wall outlet.

2

Installing the Residential Gateway

Introduction

This chapter describes how to properly install the Residential Gateway and to connect the Residential Gateway to a computer and other devices.

In This Chapter

- Installation Preparations12
- Install the Residential Gateway17
- Install the Battery20
- MoCA Installation Guidelines22

Installation Preparations

Before installing the Residential Gateway, make sure that your system meets or exceeds the requirements listed in this section. Also, make sure that you have prepared your home and home devices as described in this section.

What Are the System Requirements for Internet Service?

To ensure that your Residential Gateway operates efficiently for high-speed Internet service, you must have an Internet-capable PC, Mac, or Internet appliance equipped with an Ethernet port.

Note: You will also need an active cable input line and an Internet connection.

Minimum Hardware Requirements for a PC

- A PC with a Pentium MMX 133 or greater processor recommended
- 32 MB of RAM
- Ethernet port

Minimum Hardware Requirements for a Macintosh

- 32 MB of RAM
- Ethernet port

Minimum Software Requirements for an Ethernet Connection

- Operating system with web browser, TCP/IP protocol

What Are the Requirements for Telephone Service?

If you intend to use the Residential Gateway for digital telephone service, verify that your home meets or exceeds all of the following requirements.

Maximum Number of Telephones

The RJ-11 telephone-style connectors on the Residential Gateway can each provide telephone service to multiple telephones, fax machines, and analog modems.

The maximum number of telephone devices connected to each RJ-11 port is limited by the total Ringing Load of the telephone devices that are connected. Many telephone devices are marked with a Ringer Equivalent Number (REN). Each telephone port on the Residential Gateway can support up to a 5 REN load.

The sum of the REN load on all of the telephone devices attached to each port must not exceed 5 REN.

Telephone Device Types

You can use telephone devices that are not labeled with a REN number, but the maximum number of attached telephone devices cannot be accurately calculated. With telephone devices that are not labeled, each device should be connected and the ring signal should be tested before adding more devices. If too many telephone devices are attached and the ring signal can no longer be heard, telephone devices should be removed until the ring signal works properly.

Telephones, fax machines, and other telephone devices use the center 2 pins of the RJ-11 connectors to connect to your primary service.

Dialing Requirements

All your telephones should be set to use Dual-Tone Multi-Frequency (DTMF) dialing. Pulse dialing may not be supported by your local service provider.

Telephone Wiring Requirements

The Residential Gateway supports connecting to the interior telephone wiring as well as connecting directly to a telephone or fax machine. The maximum distance from the unit to the most distant telephone device must not exceed 1000 feet (300 meters). Use 26-gauge twisted-pair, or larger, telephone wiring.

Important: Connection to an existing or a new permanently installed home telephone wiring network should be completed by a qualified installer or at the direction of your telephone service provider.

What Types of Service Accounts Do I Need?

Depending upon the features your service provider offers, you may need to establish one or both of the following accounts:

- A high-speed Internet access account, if your Residential Gateway supports an Internet connection
- An account for telephone service, if your Residential Gateway supports digital telephone service

Refer to one of the following topics to learn more about the types of service accounts that you may need to establish.

High-Speed Internet Access Account

If you do *not* have a high-speed Internet access account, your service provider will set up your account and become your Internet Service Provider (ISP). Internet access enables you to send and receive e-mail, access the World Wide Web, and receive other Internet services.

You will need to give your service provider information about the Residential Gateway in order to use the high-speed Internet feature that this product offers. Refer to *Information Your Service Provider Needs* (on page 14) to learn how to locate the information your service provider needs to establish a high-speed Internet access account for the Residential Gateway

I Already Have a High-Speed Internet Access Account

If you have an existing high-speed Internet access account, you will need to give your service provider the serial number and MAC address of the Residential Gateway in order to use the high-speed Internet feature that this product offers. Refer to *Information Your Service Provider Needs* (on page 14) to learn how to locate this information.

Information Your Service Provider Needs

You will need to give your service provider the following information, which is printed on the bar code label attached to the device:

- The Serial Number (S/N) of the Residential Gateway. The serial number consists of a series of nine digits.
- The Media Access Control (CM MAC) address of the Residential Gateway. The CM MAC address consists of a series of 12 alphanumeric characters.
- The Media Access Control (MAC) address of the Residential Gateway media terminal adapter (MTA MAC). The MTA MAC address consists of a series of 12 alphanumeric characters.

The following illustration shows a typical bar coded label; the image may vary from the label on the actual product.

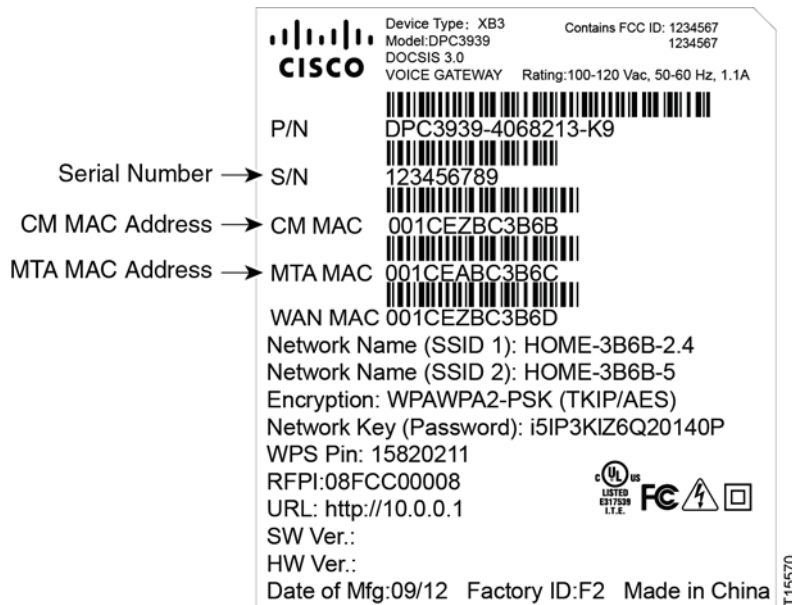

Write down these numbers in the spaces provided:

Serial Number _____

CM MAC Address _____

MTA MAC Address _____

Telephone Service

You will need to establish a telephone account with your local service provider to use your Residential Gateway for telephone service.

When you contact your service provider, you may be able to transfer your existing telephone numbers. If not, then your cable telephony service provider will assign a new telephone number to enable your voice service(s). Discuss these options with your telephony service provider.

Where Is the Best Location for My Residential Gateway?

The ideal location for your Residential Gateway is where it has access to outlets and other devices. Think about the layout of your home or office, and consult with your service provider to select the best location for your Residential Gateway. Read this user guide thoroughly before you decide where to place your Residential Gateway.

Consider these recommendations:

- Choose a location close to your computer if you will also use the Residential Gateway for high-speed Internet service.
- Choose a location that is near an existing RF coaxial connection to eliminate the need for an additional RF coaxial outlet.
- Choose a location that is relatively protected from accidental disturbance or harm, such as a closet, basement, or other protected area.
- Choose a location so that there is plenty of room to guide the cables away from the Residential Gateway without straining or crimping them.
- Choose a location that allows adequate ventilation around the Residential Gateway.
- Choose a location for the Residential Gateway that is adjacent to your telephone equipment if you plan on connecting your phone directly to the Residential Gateway.

Note: If you are using the Residential Gateway to provide service to several telephones, a professional installer can connect the Residential Gateway to your existing home telephone wiring.

Install the Residential Gateway

This section describes how to connect your Residential Gateway to support the services that the Residential Gateway offers.

Connect Devices to the Residential Gateway

Professional installation may be available. Contact your local service provider for further assistance.

The following diagram illustrates one of the various networking options that are available to you.

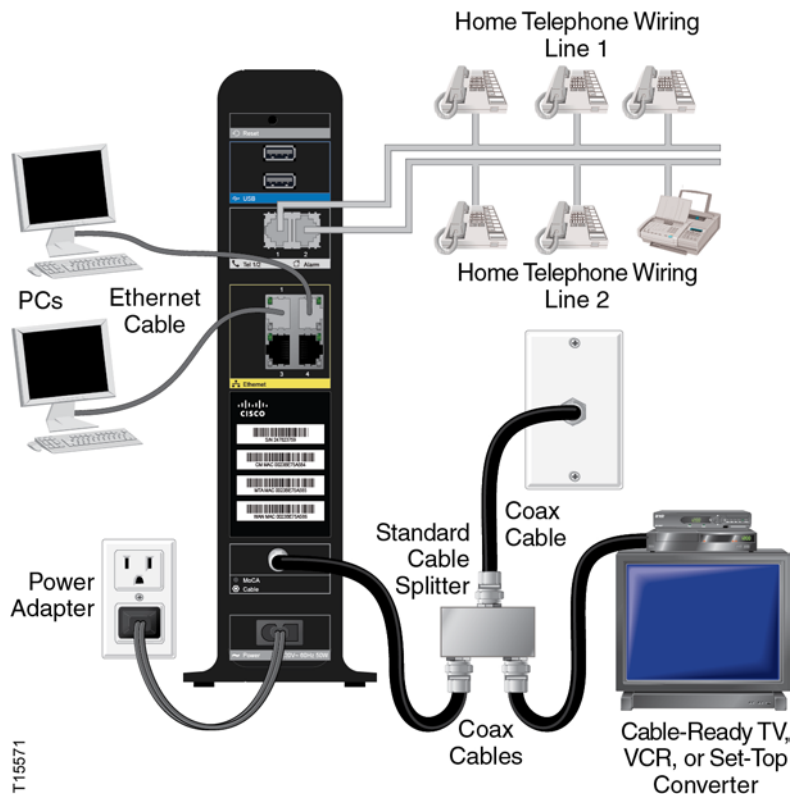

Connect the Residential Gateway

The following installation procedure ensures proper setup and configuration for the Residential Gateway.

- 1 Choose an appropriate and safe location to install the Residential Gateway (close to a power source, an active cable connection, your PC-if using high-speed Internet, and your telephone lines-if using VoIP). For assistance, refer to *Where Is the Best Location for My Residential Gateway?* (on page 16).



WARNING:

- To prevent possible damage to equipment, disconnect any other telephone service before connecting your Residential Gateway to the same wires.
- Hazardous electrical voltages can exist on the telephone, Ethernet, or coax cable wiring. Be sure to disconnect AC power from all devices while installing your service.
- All wiring and connections must be properly insulated to prevent electrical shock.
- Telephone connections to an installed home telephone wiring network should be done by a qualified installer. The cable telephone service provider may offer professional installation and connection to the home telephone wiring network. A fee may be charged for this service.

2 Power off your PC and other networking device; then, unplug them from the power source.

3 Connect the active RF coaxial cable from your service provider to the coax connector labeled **MoCA/CABLE** on the back of the Residential Gateway.

Note: To connect a TV, DHCT, set-top, or VCR from the same cable connection, you will need to install a cable signal splitter (not included). Always check with your service provider before using a splitter as a splitter may degrade the signal.

For more information about a MoCA installation, see *MoCA Installation Guidelines* (on page 22).

4 Connect your PC to the Residential Gateway using one of the following methods:

- **Ethernet Connection.** Connect one end of an Ethernet cable to the Ethernet port on your PC, and connect the other end to the **Ethernet** port on the back of the Residential Gateway.
- **Wireless Connection.** Make sure that your wireless device is powered up. You will need to associate your wireless device with the Residential Gateway once the Residential Gateway is operational. Follow the directions provided with your wireless device for associating with a wireless access point. Make sure that either the **2.4 GHz** or the **5 GHz** indicator is ON.

For more information about the factory default configuration of the DPC3939, see *Configure Wireless Settings* (on page 26).

5 If your Residential Gateway supports digital telephone service (VoIP), connect one end of a telephone jumper cable (not included) to a telephone outlet in your home or to a telephone or fax machine. Then connect the other end of the jumper cable to the appropriate RJ-11 **Tel1** or **Alarm/Tel2** port on the back of the Residential Gateway.

Notes: Telephones that require electrical connectors other than RJ-11 may require an external adapter (sold separately).

- 6 Locate the AC power cord provided with your Residential Gateway. Connect the barrel connector end of the power cord into the power input on the back of the Residential Gateway. Then, plug the other end of the power cord into an AC outlet.

The Residential Gateway will perform an automatic search to locate and sign on to the broadband data network. This process may take up to 2-5 minutes. The Residential Gateway will be ready for use when the **Power**, **US/DS**, and **Online** LEDs on the front panel of the Residential Gateway stop blinking and remain on continuously.

- 7 Plug in and power on your PC and other home network devices. If one or more of these devices uses wireless networking, the **2.4 GHz** or **5 GHz** LED on the Residential Gateway should be on or blinking.
- 8 At this point, the installation is complete, and you can begin surfing the Internet.
Note: If your PC does not have Internet access, refer to *How Do I Configure TCP/IP Protocol?* (on page 48) for information on how to configure your PC for TCP/IP. For Internet devices other than PCs, refer to the DHCP or IP Address configuration section of the User Guide or Operations Manual for those devices.

Install the Battery

Your Residential Gateway may include one rechargeable Lithium-Ion battery to provide stand-by operation in the event of an AC power failure. We recommend that you install the battery before mounting the Residential Gateway to a wall (if you decide to do so) and before installing the Residential Gateway in your home.

It is possible to use the Residential Gateway without the battery. However, if you choose to operate the Residential Gateway without a battery, you will not have telephone service during a power outage.

For information on battery maintenance, refer to *Maintaining the Battery* (on page 43).

Installing the Battery

Installing the battery requires no tools. Follow these instructions to install the battery.



WARNING:

Fully charged high-capacity rechargeable batteries should be handled with care. Replace only with the battery recommended by the manufacturer. Do not disassemble it or attempt to recharge the battery outside the system. Do not crush, puncture, dispose of in a fire, short the external contacts, or expose to high temperature or immerse in water or other liquids. Dispose of the battery in accordance with local regulations and instructions from your service provider.

- 1 Turn the Residential Gateway so that you are facing the side with the battery compartment.
- 2 Gently release the latch to open the battery cover and gain access to the battery compartment.

- 3 Insert the battery into the battery compartment. Do not force the battery into the compartment, but be sure to press the battery all the way in until it seats fully.
Important: Take care to position the battery correctly. Insert the battery only as shown in the following illustration.



- 4 Close the battery compartment door.
Important: After you install the Residential Gateway and plug it into an AC electrical outlet as described in *Install the Residential Gateway* (on page 17), it can take as long as 24 hours for the battery to charge fully. However, you can begin using your high-speed Internet and telephone service immediately after installation. See *Normal Operations (AC Power Applied)* (on page 40) for information on how the LEDs on the front of the Residential Gateway indicate the state of the battery charge.

MoCA Installation Guidelines

MoCA is an in-home distribution technology that leverages the coax cable networks that exist in more than 90% of US households. MoCA is an attractive option because it provides a relatively low-cost method of getting DVR and other multimedia sharing video services to multiple TVs within the home without additional cable installation.



MoCA operates over the physical layer of the home coaxial cable plant in the 1000-1500 MHz spectrum. Its infrastructure begins at the service provider's drop cable at the first passive splitter connected to the home coax network.

Recommended Installation Guidelines

The following guidelines are recommended for a home network prior to installation.

- The maximum cable distance supported between the network coordinator and the last outlet is 300 feet.
- The maximum attenuation permitted between nodes is 25 dB.
- Branches within the home-network should flow from secondary splitters.
- Assess the home network and determine the data rates between coax outlets.
- Sectionalize the individual MoCA nodes to validate proper operation of the device's MoCA interface.
- Evaluate and certify the integrity of the coax cable plant between MoCA nodes.

- Identify sources of noise and interference on the MoCA spectrum.
- Re-qualify additional coax outlets to support MoCA-enabled devices and services.

Pre-Installation Instructions

Prior to installing MoCA, complete the following tasks:

- 1 Contact your service provider and ensure that the Residential Gateway is enabled for MoCA services.
- 2 Ensure that a MoCA filter has been installed by your service provider at the home's entry point, as shown in the following illustration:

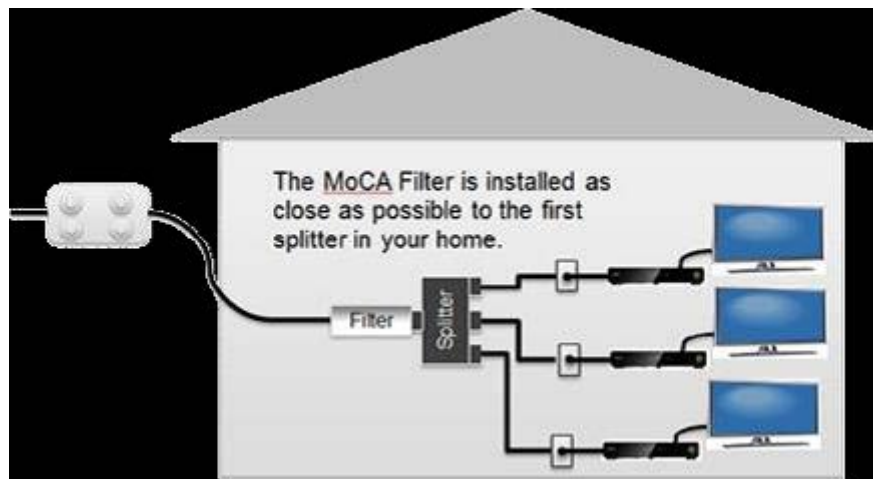

- 3 To log-in to the Residential Gateway, enter **http://10.0.0.1** in the web address (URL) field of any browser and press the **Enter** key. Then enter the following when prompted:
 - Username: **admin**
 - Password: **password**
- 4 From the menu options, go to **Gateway/Connections/MoCA** and ensure that MoCA is set to **enable**.
- 5 If you have not already done so, connect the coaxial cable from a wall cable outlet within the home network to the **MoCA/Cable** port on the rear panel of the Residential Gateway.
- 6 If you have not already done so, connect the AC power cord provided with your Residential Gateway. Connect the barrel connector end of the power cord into the power input on the back of the Residential Gateway. Then, plug the other end of the power cord into an AC outlet.

Chapter 2 Installing the Residential Gateway

The Residential Gateway will perform an automatic search to locate and sign on to the broadband data network. This process may take up to 2-5 minutes. The Residential Gateway will be ready for use when the **Power**, **US/DS**, and **Online** LEDs on the front panel of the residential gateway stop blinking and remain on continuously.

- 7 Wait a few seconds for the device to be discovered. When discovered, an LED labeled **2.4 GHz** or **5 GHz** should turn on. At this point, a MoCA node should be active in the network.
- 8 If you have not already done so, connect an Ethernet compatible device (for example, a set-top, computer, or PlayStation) to the Ethernet port on the Residential Gateway. The **ONLINE** LED should turn on and the device should be ready to use.
- 9 Follow the steps above to connect additional Residential Gateways to the network; note that up to 15 residential gateways can be added to a MoCA network.
- 10 From the user interface, you can monitor a limited number of parameters associated with the MoCA network. You may login at any time to check for status or for troubleshooting purposes.

3

Configuring the Residential Gateway

Introduction

This chapter provides instructions for configuring the Residential Gateway to operate correctly. Examples of the configuration pages are for illustration purposes only and may differ from the pages shown on your Residential Gateway.

Important: If you are not familiar with the network configuration procedures detailed in this chapter, contact your service provider before attempting to change any of the Residential Gateway settings.

In This Chapter

- Configure Wireless Settings26

Configure Wireless Settings

Setting up the Wireless Residential Gateway for wireless communication provides you with the freedom to connect to the Internet from any location within range of the Wireless Access Point (WAP) without having to use wired connections. This section provides procedures for configuring the WAP to meet your needs. These options are available as tabs on the **Gateway > Connection > WiFi** page.

- **Private WiFi Network** - Use this page to choose the wireless network mode that the Wireless Residential Gateway will use to set up other basic features including Security mode and Network Password.
- **MAC Filter Settings**- Use this page to configure MAC address filtering for your wireless network separately for 2.4 GHz and 5 GHz networks.
- **Add WPS Client** - Use this page to manually set up and connect WPS clients with the WPS PIN method and Push Button.

Log in to the Residential Gateway

- 1 On your PC, open the web browser that you prefer to use.
- 2 In the web address (URL) field, enter **http://10.0.0.1** and press the **Enter** key.
- 3 When prompted enter the following username and password:
 - Username: **admin**
 - Password: **password**

Private WiFi Network

From the **Gateway > Connection > WiFi** page, click the **Edit** buttons in 2.4 GHz or 5GHz network to configure Network Name (SSID), Mode, Security Mode. Channel Selection and Network Password and Enable/Disabling the wireless network or Broadcasting Network Name.

The screenshot shows the configuration interface for Wi-Fi settings. On the left is a navigation menu with options like Gateway, Connection, Status, XFINITY Network, Local IP Network, Wi-Fi (selected), MoCA, Firewall, Software, Hardware, Wizard, Connected Devices, Parental Control, Advanced, and Troubleshooting. The main content area is titled 'Gateway > Connection > Wi-Fi' and includes a 'more' link for managing settings.

Private Wi-Fi Network

Name	Frequency Band:	MAC Address	Security Mode	
HOME-9E9D-2.4	2.4GHz	54:BE:F7:B4:F3:78	WPAWPA2-PSK (TKIP/AES)	<input type="button" value="EDIT"/>
HOME-9E9D-5	5GHz	54:BE:F7:B9:80:40	WPAWPA2-PSK (TKIP/AES)	<input type="button" value="EDIT"/>

MAC Filter Setting

You can control the Wi-Fi access to the USG using the below Mac-Filter settings.

SSID:

MAC Filtering Mode:

Wi-Fi Control List(up to 16 items)

#	Device Name	MAC Address
Auto-Learned Wi-Fi Devices		
	Device Name	MAC Address
Manually-Added Wi-Fi Devices		
	Device Name	MAC Address
	<input type="text"/>	<input type="text"/> : <input type="text"/> : <input type="text"/> : <input type="text"/> : <input type="text"/> : <input type="text"/>
		<input type="button" value="ADD"/>

Configure the Residential Gateway for the 2.4 GHz Wireless Network

This section describes how to configure wireless settings for the 2.4 GHz wireless network.

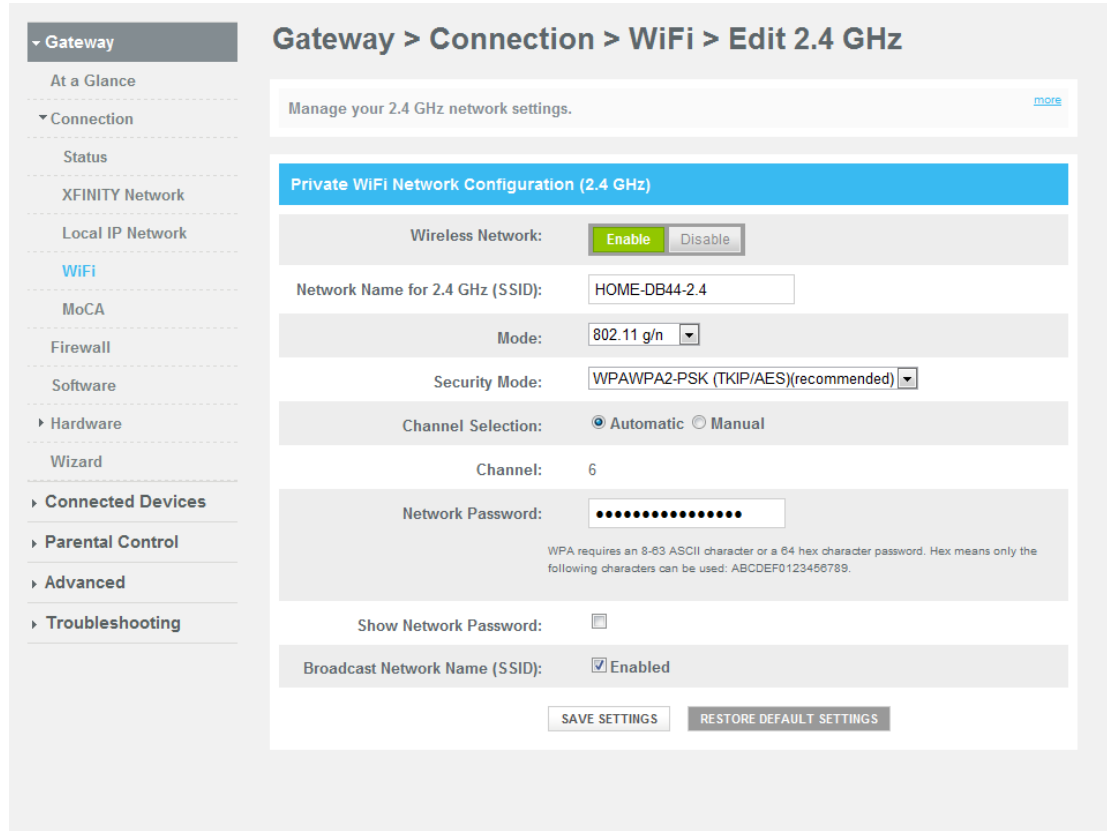

Use the descriptions and instructions in the following table to manually configure the basic settings for wireless communication for the Residential Gateway. After you make your selections, click **Save Settings** to apply your changes or **Restore Default Settings** to set values back to factory default values.

Field Label	Description
Wireless Network	Use this setting to Enable or Disable the wireless network.
Network Name for 2.4 GHz (SSID 1)	<p>The SSID is the name of your wireless network. The SSID is used by wireless technology to identify your network from other wireless networks in the area. The SSID can be up to 32 characters long.</p> <p>The factory-set SSID is HOME-XXXX-2.4 where XXXX is the last 4 digits of the cable modem MAC address, which is found on the label located on the bottom of the Residential Gateway.</p> <p>The factory-set SSID is a unique identity and does not need to be changed unless you choose to do so.</p>

Field Label	Description
Mode	<p>Choose one of these options for the network mode:</p> <ul style="list-style-type: none"> ■ 802.11 g/n ■ 802.11 b/g/n <p>Important: When TKIP authentication only is selected, B/G/N Mixed network mode is not available.</p>
Security Mode	<p>Choose one of these options for the security mode:</p> <ul style="list-style-type: none"> ■ Open (risky) ■ 64 bits (5 Ascii characters or 10 Hex digits) ■ 128 bits (13 Ascii characters or 26 Hex digits) ■ WPA-PSK(TKIP) (8 to 63 Ascii characters or 64 Hex digits) ■ WPA-PSK(AES) (8 to 63 Ascii characters or 64 Hex digits) ■ WPA2-PSK(TKIP) (8 to 63 Ascii characters or 64 Hex digits) ■ WPA2-PSK(AES) (8 to 63 Ascii characters or 64 Hex digits) ■ WPA2-PSK(TKIP/AES) (8 to 63 Ascii characters or 64 Hex digits) ■ WPAWPA2-PSK(TKIP/AES) recommended (8 to 63 Ascii characters or 64 Hex digits) <p>Note: Not all wireless adapters support WPA2. WPA is supported across a wider range of devices. Whether you use WPA or WPA2, make sure to use a "strong" passphrase. A strong passphrase is a string of random characters at least 21 characters in length.</p>
Channel Selection	<p>Automatic. Select Automatic (factory default) to have channel selected for you.</p> <p>Manual. Select Manual to select channels from the Channel field.</p>
Channel	<p>When the Manual option is chosen for Channel Selection, use this field to select a channel from 1 through 11.</p> <p>Note: Only channels 1, 6 and 11 are non-overlapping channels.</p>
Network Password	<p>Depending upon Security Mode selected, the Network Password can have different requirements. The factory-set password value can be found on the label located on the bottom of your Residential Gateway.</p>
Show Network Password	<p>To make the Network Password become visible to the user or not. Every time the page is opened, this box is unchecked for security reasons.</p>

Field Label	Description
Broadcast Network Name (SSID)	<p>When this box is checked (factory default), the Residential Gateway transmits or advertises its presence to other wireless devices. Client devices can automatically detect the access point when this is enabled.</p> <p>If you want to hide your network from wireless clients, leave this box unselected. When your network is hidden, you will need to configure each of your wireless client devices manually.</p>

Configure the Residential Gateway for the 5 GHz Wireless Network

This section describes how to configure wireless settings for the 5 GHz wireless network.

The screenshot shows the configuration page for the 5 GHz Wi-Fi network. The breadcrumb trail is **Gateway > Connection > Wi-Fi > Edit 5 GHz**. The page title is **Gateway > Connection > Wi-Fi > Edit 5 GHz**. The main heading is **Private Wi-Fi Network Configuration (5 GHz)**. The settings are as follows:

- Wireless Network:** Enable Disable
- Network Name for 5 GHz (SSID):** HOME-9E9D-5
- Mode:** 802.11 a/n
- Security Mode:** WPAWPA2-PSK (TKIP/AES)(recommended)
- Channel Selection:** Automatic Manual
- Channel:** 40
- Network Password:** [Redacted]
- Show Network Password:**
- Broadcast Network Name (SSID):** Enabled

Buttons at the bottom: **SAVE SETTINGS** and **RESTORE DEFAULT SETTINGS**.

Use the descriptions and instructions in the following table to manually configure the basic settings for wireless communication for the Residential Gateway. After you make your selections, click **Save Settings** to apply your changes or **Restore Default Settings** to set values back to factory default values.

Field Label	Description
Wireless Network	Use this setting to Enable or Disable the wireless network.
Network Name for 5 GHz (SSID 2)	<p>The SSID is the name of your wireless network. The SSID is used by wireless technology to identify your network from other wireless networks in the area. The SSID can be up to 32 characters long.</p> <p>The factory-set SSID is HOME-XXXX-5 where XXXX is the last 4 digits of the cable modem MAC address, which is found on the label located on the bottom of the Residential Gateway.</p> <p>The factory-set SSID is a unique identity and does not need to be changed unless you choose to do so.</p>
Mode	<p>Choose one of these options for the network mode:</p> <ul style="list-style-type: none"> ■ 802.11 a/n ■ 801.11 n <p>Important: The following Security mode is recommended: WPAWPA2-PSK (TKIP/AES).</p>
Security Mode	<p>Choose one of these options for the security mode.</p> <ul style="list-style-type: none"> ■ Open (risky) ■ WEP 64 bits (5 Ascii characters or 10 Hex digits) ■ WEP 128 bits (13 Ascii characters or 26 Hex digits) ■ WPA-PSK(TKIP) (8 to 63 Ascii characters or 64 Hex digits) ■ WPA-PSK(AES) (8 to 63 Ascii characters or 64 Hex digits) ■ WPA2-PSK(TKIP) (8 to 63 Ascii characters or 64 Hex digits) ■ WPA2-PSK(AES) (8 to 63 Ascii characters or 64 Hex digits) ■ WPA2-PSK(TKIP/AES) (8 to 63 Ascii characters or 64 Hex digits) ■ WPAWPA2-PSK(TKIP/AES) recommended (8 to 63 Ascii characters or 64 Hex digits) <p>Note: Not all wireless adapters support WPA2. WPA is supported across a wider range of devices. Whether you use WPA or WPA2, make sure to use a strong passphrase. A strong passphrase is a string of random characters at least 21 characters in length.</p>

Field Label	Description
Channel Selection	<p>Automatic. Select Automatic (factory default) to have channel selected for you.</p> <p>Manual. Select Manual to select channels from the Channel field.</p>
Channel	<p>When the Manual option is chosen for Channel Selection, use this field to select a channel from 40, 48, 153, and 161.</p>
Network Password	<p>Depending upon Security Mode selected, the Network Password can have different requirements. The factory-set password value can be found on the label located on the bottom of your Residential Gateway.</p>
Show Network Password	<p>To make the Network Password become visible to the user or not. Every time the page is opened, this box is unchecked for security reasons.</p>
Broadcast Network Name (SSID)	<p>When this box is checked (factory default), the Residential Gateway transmits or advertises its presence to other wireless devices. Client devices can automatically detect the access point when this is enabled.</p> <p>If you want to hide your network from wireless clients, leave this box unselected. When your network is hidden, you will need to configure each of your wireless client devices manually.</p>

Configure MAC Address Filtering

Use this page to configure MAC address filtering for your wireless network separately for 2.4 GHz and 5 GHz networks. This feature allows you to give access privileges to certain wireless clients.

- ▼ Gateway
- At a Glance
- ▼ Connection
- Status
- XFINITY Network
- Local IP Network
- WiFi
- MoCA
- Firewall
- Software
- ▶ Hardware
- Wizard
- ▶ Connected Devices
- ▶ Parental Control
- ▶ Advanced
- ▶ Troubleshooting

Gateway > Connection > WiFi

Manage your WiFi connection settings. [more](#)

Private WiFi Network

Name	Frequency Band:	MAC Address	Security Mode	
HOME-DB44-2.4	2.4 GHz	70:54:D2:00:53:50	WPAWPA2-PSK (TKIP/AES)	EDIT
HOME-DB44-5	5 GHz	70:54:D2:00:63:E8	WPAWPA2-PSK (TKIP/AES)	EDIT

[ADD WIFI PROTECTED SETUP \(WPS\) CLIENT](#)

MAC Filter Setting

You can control the WiFi access to the USG using the below Mac-Filter settings.

SSID: HOME-DB44-2.4

MAC Filtering Mode: Allow-All

WiFi Control List (up to 10):

#	Device Name	MAC Address
Auto-Learned WiFi Devices		
Device Name	MAC Address	
Manually-Added WiFi Devices		
Device Name	MAC Address	
	<input style="width: 100px;" type="text"/> : <input style="width: 100px;" type="text"/> : <input style="width: 100px;" type="text"/> : <input style="width: 100px;" type="text"/> : <input style="width: 100px;" type="text"/> : <input style="width: 100px;" type="text"/>	
	ADD	

[SAVE FILTER SETTING](#)

Use the descriptions and instructions in the following table to configure MAC address filtering for your wireless network. After you make your selections, click **Save Filter Settings** to apply your changes.

Field	Description
SSID	<p>Click the SSID drop-down arrow to select the SSID to which you would like to apply the filtered clients:</p> <ul style="list-style-type: none"> ■ Allow All- allow access to all the clients included in WiFi Control List ■ Allow- allow access to the selected clients in WiFi Control List ■ Deny- deny access to the selected clients in WiFi Control List
Manually-Added WiFi Devices	Enter the name of the device in the Device Name field.
Device Name	
Manually-Added WiFi Devices	Enter the MAC address of the device in the MAC Address fields.
MAC Address	Click ADD . The WiFi client is added to the WiFi Control List.

Configure and Connect WiFi Protected Setup Clients

Use this page to manually set up and connect WPS clients, WPS PIN method and Push Button.

The screenshot shows the 'Add WiFi Client (WPS)' configuration page. On the left is a sidebar with a 'Gateway' menu containing options like 'At a Glance', 'Connection', 'Status', 'XFINITY Network', 'Local IP Network', 'WiFi', 'MoCA', 'Firewall', 'Software', 'Hardware', 'Wizard', 'Connected Devices', 'Parental Control', 'Advanced', and 'Troubleshooting'. The main content area has a breadcrumb trail: 'Gateway > Connection > WiFi > Add WiFi Client'. Below the breadcrumb is a tip: 'If a WiFi device supports WiFi Protected Setup (WPS), use the Gateway's WPS feature to simplify connection to your network.' The main form is titled 'Add WiFi Client (WPS)' and contains the following fields:

- SSID:** A dropdown menu with options 'HOME-DB44-2.4', 'HOME-DB44-5', and 'HOME-DB44-5'. The 'HOME-DB44-2.4' option is currently selected.
- WiFi Protected Setup (WPS):** A toggle switch currently set to 'Enable'.
- Security:** WPA-WPA2-Personal
- Encryption:** AES+TKIP
- AP PIN:** 21968259
- WPS PIN Method:** A toggle switch currently set to 'Enable'.
- Connection Options:** A dropdown menu set to 'Push Button'.

At the bottom of the form, there is a note: 'To pair, select the Pair button and your wireless device will connect within two minutes. You may also press the [push] button on this device.' Below the note are two buttons: 'PAIR' and 'CANCEL'.

Use the descriptions and instructions in the following table to manually set up and connect WPS clients, WPS PIN method and Push Button. After you make your selections, click **Pair** to connect your wireless device.

Field	Description
SSID	Click the SSID drop-down arrow to select the SSID to connect a client to using WPS.
WiFi Protected Setup (WPS)	Enable - Click to make the WPS mechanism active. Disable - Click to make the WPS mechanism inactive.
WPS PIN Method	Enable - Click to make the WPS PIN Method active. Disable - Click to make the WPS PIN Method inactive.
Connection Options	Click the Connection Options drop-down arrow to select the connection method to use. When selecting the Push Button method, click PAIR after the client has asked the WPS button be pushed. The wireless device will connect within two minutes.
Wireless Clients PIN	To pair, select the Pair button and your wireless device will connect within two minutes. You may also press the [push] button on this device. The Wireless Clients PIN, found from client, needs to be entered in this field and click PAIR.

4

Operation of Front Panel Indicators

Introduction

This section describes the behavior of the front panel indicators when the Residential Gateway is first powered up, during normal operations, and in special conditions.

In This Chapter

- Initial Power Up, Calibration, and Registration (AC Power applied)38
- Normal Operations (AC Power Applied)40
- Special Conditions41

Initial Power Up, Calibration, and Registration (AC Power applied)

The following chart illustrates the sequence of steps and the corresponding appearance of the Residential Gateway front panel LED status indicators during power up, calibration, and registration on the network when AC power is applied to the Residential Gateway. Use this chart to troubleshoot the power up, calibration, and registration process of your Residential Gateway.

Note: After the Residential Gateway completes Step 7 (Data Network Registration Complete), the Residential Gateway proceeds immediately to Normal Operations. See *Normal Operations (AC Power applied)* (on page 40).

Front Panel LED Status Indicators During Initial Power Up, Calibration, and Registration							
Part 1, High Speed Data Registration							
Step:		1	2	3	4	5	6
Front Panel Indicator		Self Test	Downstream Scan	Downstream Signal Lock	Ranging	Requesting IP Address	Request High Speed Data Provisioning File
1	POWER	On	On	On	On	On	On
2	US/DS	On	Blinking	On	On	On	On
3	ONLINE	On	Off	Off	Off	Off	Blinking
4	2.4 GHz	On	On or Blinking	On or Blinking	On or Blinking	On or Blinking	On or Blinking
5	5 GHz	On	On or Blinking	On or Blinking	On or Blinking	On or Blinking	On or Blinking
6	TEL ¹	On	Off	Off	Off	Off	Off
7	TEL ²	On	Off	Off	Off	Off	Off
8	BATTERY	<ul style="list-style-type: none"> ■ On - When battery is charged ■ Blinks - When battery charge is low ■ Off - When there is no battery in the unit 					

Initial Power Up, Calibration, and Registration (AC Power applied)

Front Panel LED Status Indicators During Initial Power Up, Calibration, and Registration						
Part 2, Telephone Registration						
Step:		7	8	9	10	11
Front Panel Indicator		Data Network Registration Complete	Requesting Telephone IP Address	Request Telephone Provisioning File	Restarting Voice Service	Telephone Registration Complete
1	POWER	On	On	On	On	On
2	US/DS	On	On	On	On	On
3	ONLINE	On	On	On	On	On
4	2.4 GHz	On or Blinking	On or Blinking	On or Blinking	On or Blinking	On or Blinking
5	5 GHz	On or Blinking	On or Blinking	On or Blinking	On or Blinking	On or Blinking
6	TEL ¹	Off	Blinking	Off	Blinking	On
7	TEL ²	Off	Off	Blinking	Blinking	On
8	BATTERY	<ul style="list-style-type: none"> ■ On - When battery is charged ■ Blinks - When battery charge is low ■ Off - When there is no battery in the unit 				

Normal Operations (AC Power Applied)

The following chart illustrates the appearance of the Residential Gateway front panel LED status indicators during normal operations when AC power is applied to the gateway.

Front Panel LED Status Indicators During Normal Conditions		
Front Panel Indicator		Normal Operations
1	POWER	On
2	US/DS	On
3	ONLINE	On
4	2.4 GHz	<ul style="list-style-type: none"> ■ On - When the wireless access point is enabled and operational ■ Blinks - When data is being transferred between the CPE and the wireless home gateway ■ Off - When the wireless access point is disabled by the user
5	5 GHz	<ul style="list-style-type: none"> ■ On - When the wireless access point is enabled and operational ■ Blinks - When data is being transferred between the CPE and the wireless home gateway ■ Off - When the wireless access point is disabled by the user
6	TEL ¹	<ul style="list-style-type: none"> ■ On - When telephony service is enabled ■ Blinks - When line 1 is in use
7	TEL ²	<ul style="list-style-type: none"> ■ On - When telephony service is enabled ■ Blinks - When line 2 is in use
8	BATTERY	<ul style="list-style-type: none"> ■ On - When battery is charged ■ Blinks - When battery charge is low ■ Off - When there is no battery in the unit

Special Conditions

The following chart describes the appearance of the Residential Gateway front panel LED status indicators during special conditions to show when you have been denied network access.

Front Panel LED Status Indicators During Special Conditions		
Front Panel Indicator		Network Access Denied
1	POWER	Slow Blinking (once per second)
2	US/DS	Slow Blinking (once per second)
3	ONLINE	Slow Blinking (once per second)
4	2.4 GHz	Slow Blinking (once per second)
5	5 GHz	Slow Blinking (once per second)
6	TEL1	Off
7	TEL2	Off
8	BATTERY	On

5

Maintaining the Battery

Introduction

This chapter describes how to maintain and replace the battery that is included with the Residential Gateway.

In This Chapter

- Location of the Battery44
- Battery Maintenance45

Location of the Battery

The following illustration shows the location of the battery.

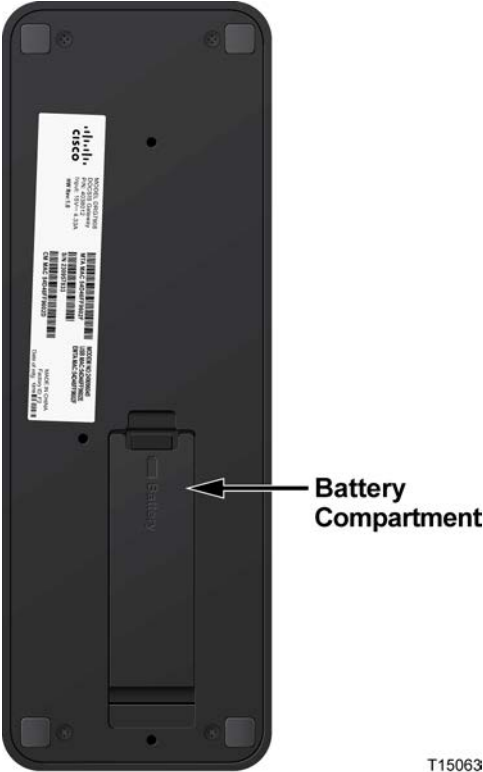

T15063

Battery Maintenance

If your Residential Gateway contains a battery backup feature, a high-capacity rechargeable battery provides stand-by operation in the event of an AC power failure. You can replace the battery without the use of any tools.



WARNING:

Fully charged high-capacity rechargeable batteries should be handled with care. Replace only with the battery recommended by the manufacturer. Do not disassemble it or attempt to recharge the battery outside the system. Do not crush, puncture, dispose of in a fire, short the external contacts, or expose to high temperature or immerse in water or other liquids. Dispose of the battery in accordance with local regulations and instructions from your service provider.

Charging the Battery

The battery begins to charge automatically as soon as you attach the Residential Gateway to the AC electrical outlet. When you first plug in the Residential Gateway, the **POWER** LED status indicator illuminates.

Important: It may take as long as 24 hours for the battery to charge fully.

Removing and Replacing the Battery

Under normal circumstances, the battery should last for several years. The **BATTERY** LED status indicator blinks to indicate that the battery should be replaced soon. Contact your service provider to obtain replacement batteries and for disposal instructions.

Follow these steps to remove and replace the battery. You can remove and replace the battery without disconnecting the AC power source.

- 1 Turn the Residential Gateway so that you are facing the side with the battery compartment.
- 2 Gently release the latch to open the battery cover and gain access to the battery compartment.
- 3 Grasp the plastic strip on the front of the battery and gently slide the battery forward to remove it from the battery compartment.

- 4 Insert a new battery into the battery compartment. Do not force the battery into the compartment, but be sure to press the battery all the way in until it seats fully.



- 5 Close the battery compartment door. The battery lock will automatically re-engage.

Important: It can take as long as 24 hours for the battery to charge fully.

Note: Dispose of the battery in accordance with local regulations and instructions from your service provider.

Using the Residential Gateway Without a Battery

If you want, you can use the Residential Gateway without a battery. If you need to remove the battery, follow the procedures found in *Removing and Replacing the Battery* (on page 45).

Important: If you choose to operate your Residential Gateway without a battery, you risk losing your telephone service during a power outage.

6

Troubleshooting the Residential Gateway

Introduction

This chapter describes the most common issues that may occur after the Residential Gateway is installed and provides possible solutions and tips for improved performance of the Residential Gateway.

In This Chapter

- Frequently Asked Questions48
- Common Troubleshooting Issues54
- Tips for Improved Performance56

Frequently Asked Questions

This section provides answers to common questions about the Residential Gateway.

How Do I Configure TCP/IP Protocol?

To configure TCP/IP protocol, you need to have an Ethernet Network Interface Card (NIC) with TCP/IP communications protocol installed on your system. TCP/IP is a communications protocol used to access the Internet. This section contains instructions for configuring TCP/IP on your Internet devices to operate with the Residential Gateway in Microsoft Windows or Macintosh environments.

TCP/IP protocol in a Microsoft Windows environment is different for each operating system. Follow the appropriate instructions in this section for your operating system.

Configuring TCP/IP on Windows 7 Systems

- 1 Open **Network Connections** by clicking the **Start** button, and then clicking **Control Panel**.
- 2 In the Search box, type **adapter**, and then, under **Network and Sharing Center**, click **View network connections**.
- 3 Right-click the connection that you want to change, and then click **Properties**. If you are prompted for an administrator password or confirmation, type the password or provide confirmation. The Local Area Connection Properties window opens.
- 4 Click the **Networking** tab.
- 5 Under **This connection uses the following items**, click either **Internet Protocol Version 4 (TCP/IPv4)** or **Internet Protocol Version 6 (TCP/IPv6)**, and then click **Properties**.
- 6 To specify IPv4 IP address settings, do one of the following:
 - To get IP settings automatically using DHCP, click **Obtain an IP address automatically**, and then click **OK**.
 - To specify an IP address, click **Use the following IP address**, and then, in the **IP address**, **Subnet mask**, and **Default gateway** boxes, type the IP address settings.
- 7 To specify IPv6 IP address settings, do one of the following:
 - To get IP settings automatically using DHCP, click **Obtain an IPv6 address automatically**, and then click **OK**.
 - To specify an IP address, click **Use the following IPv6 address**, and then, in the **IPv6 address**, **Subnet prefix length**, and the **Default gateway** boxes, type the IP address settings.

- 8 To specify DNS server address settings, do one of the following:
 - To get a DNS server address automatically using DHCP, click **Obtain DNS server address automatically**, and then click **OK**.
 - To specify a DNS server address, click **Use the following DNS server addresses**, and then, in the **Preferred DNS server** and **Alternate DNS server** boxes, type the addresses of the primary and secondary DNS servers.
- 9 To change advanced DNS, WINS, and IP settings, click **Advanced**.
- 10 When you are finished, click **OK**.
- 11 Try to access the Internet. If you cannot access the Internet, contact your service provider for further assistance.

Configuring TCP/IP on Windows XP Systems

- 1 Click **Start**, and depending on your Start menu setup, choose one of the following options:
 - If you are using the Windows XP Default Start Menu, select **Connect to**, choose **Show all connections**, and then go to step 2.
 - If you are using the Windows XP Classic Start Menu, select **Settings**, choose **Network Connections**, click **Local Area Connection**, and then go to step 3.
- 2 Double-click the **Local Area Connection** icon in the LAN or High-Speed Internet section of the Network Connections window.
- 3 Click **Properties** in the Local Area Connection Status window.
- 4 Click **Internet Protocol (TCP/IP)**, and then click **Properties** in the Local Area Connection Properties window.
- 5 Select both **Obtain an IP address automatically** and **Obtain DNS server address automatically** in the Internet Protocol (TCP/IP) Properties window, and then click **OK**.
- 6 Click **Yes** to restart your computer when the Local Network window opens. The computer restarts. The TCP/IP protocol is now configured on your PC, and your Ethernet devices are ready for use.
- 7 Try to access the Internet. If you cannot access the Internet, contact your service provider for further assistance.

Configuring TCP/IP on Macintosh Systems

- 1 Click the **Apple** icon in the upper-left corner of the Finder. Scroll down to **Control Panels**, and then click **TCP/IP**.
- 2 Click **Edit** on the Finder at the top of the screen. Scroll down to the bottom of the menu, and then click **User Mode**.
- 3 Click **Advanced** in the User Mode window, and then click **OK**.
- 4 Click the Up/Down selector arrows located to the right of the Connect Via section of the TCP/IP window, and then click **Using DHCP Server**.

- 5 Click **Options** in the TCP/IP window, and then click **Active** in the TCP/IP Options window.
Note: Make sure that the **Load only when needed option** is *unchecked*.
- 6 Verify that the **Use 802.3** option located in the upper-right corner of the TCP/IP window is unchecked. If there is a check mark in the option, uncheck the option, and then click **Info** in the lower-left corner.
- 7 Is there a Hardware Address listed in this window?
 - If **yes**, click **OK**. To close the TCP/IP Control Panel window, click **File**, and then scroll down to click **Close**. You have completed this procedure.
 - If **no**, you must power off your Macintosh.
- 8 With the power off, simultaneously press and hold down the **Command (Apple)**, **Option**, **P**, and **R** keys on your keyboard. Keeping those keys pressed down, power on your Macintosh but do not release these keys until you hear the Apple chime at least three times, then release the keys and let the computer restart.
- 9 When your computer fully reboots, repeat steps 1 through 7 to verify that all TCP/IP settings are correct. If your computer still does not have a Hardware Address, contact your authorized Apple dealer or Apple technical support center for further assistance.

How Do I Renew the IP Address on My PC?

If your PC cannot access the Internet after the Residential Gateway is online, it is possible that your PC did not renew its IP address. Follow the appropriate instructions in this section for your operating system to renew the IP address on your PC.

Renewing the IP Address on Windows 7 Systems

- 1 Click the Windows **Start** button.
- 2 Type **cmd** in the Search box. The cmd window opens.
- 3 Type **ipconfig/renew** and press **Enter** to renew the IP address of the computer.

Renewing the IP Address on Windows XP Systems

- 1 Click **Start**, and then click **Run**. The Run window opens.
- 2 Type **cmd** in the Open field and click **OK**. A window with a command prompt opens.
- 3 Type **ipconfig/release** at the C:/ prompt and press **Enter**. The system releases the IP address.
- 4 Type **ipconfig/renew** at the C:/ prompt and press **Enter**. The system displays a new IP address.

- 5 Click the **X** in the upper-right corner of the window to close the Command Prompt window. You have completed this procedure.

Note: If you cannot access the Internet, contact your service provider for further assistance.

Renewing the IP Address on Windows 95, 98, 98SE, and ME Systems

- 1 Click **Start**, and then click **Run**. The Run window opens.
- 2 In the Open field, type **windows** and click **OK**. The IP Configuration window opens.
- 3 Click the down arrow to the right of the top field, and select the Ethernet adapter that is installed on your PC. The IP Configuration window displays the Ethernet adapter information.
- 4 Click **Release**, and then click **Renew**. The IP Configuration window displays a new IP address.
- 5 Click **OK** to close the IP Configuration window and complete this procedure.

Note: If you cannot access the Internet, contact your service provider for further assistance.

Renewing the IP Address on Macintosh Systems

- 1 Close all open programs.
- 2 Open your **Preferences** folder.
- 3 Drag the **tcp/ip preferences** file to the Trash.
- 4 Close all open windows and empty the Trash.
- 5 Restart your computer.
- 6 As your computer starts, simultaneously press and hold down the **Command (Apple)**, **Option, P**, and **R** keys on your keyboard. Keeping those keys pressed down, power on your Macintosh but do not release these keys until you hear the Apple chime at least three times; then, release the keys and let the computer restart.
- 7 When your computer fully reboots, click the **Apple** icon in the upper-left corner of the Finder. Scroll down to **Control Panels**, and then click **TCP/IP**.
- 8 Click **Edit** on the Finder at the top of the screen. Scroll down to the bottom of the menu, and then click **User Mode**.
- 9 Click **Advanced** in the User Mode window, and then click **OK**.
- 10 Click the Up/Down selector arrows located to the right of the Connect Via section of the TCP/IP window, and then click **Using DHCP Server**.
- 11 Click **Options** in the TCP/IP window, and then click **Active** in the TCP/IP Options window.

Note: In some cases, the **Load only when needed** option does not appear. If it appears, select the option. A check mark appears in the option.

- 12 Verify that the **Use 802.3** option located in the upper-right corner of the TCP/IP window is not selected. If there is a check mark in the option, select the option to clear the check mark, and then click **Info** in the lower-left corner.
- 13 Is there a Hardware Address listed in this window?
 - If **yes**, click **OK**. To close the TCP/IP Control Panel window, click **File**, and then scroll down to click **Close**.
 - If **no**, repeat these instructions from step 6.
- 14 Reboot your computer.

What if I Don't Subscribe to Cable TV?

If cable TV is available in your area, data service may be made available with or without subscribing to cable TV service. Contact your local service provider for complete information on cable services, including high-speed Internet access.

How Do I Arrange for Installation?

Call your service provider to inquire about professional installation. A professional installation ensures proper cable connection to the Residential Gateway and to your PC, and it ensures the proper configuration of all hardware and software settings. Contact your service provider for more information about installation.

How Does the Residential Gateway Connect to My Computer?

The Residential Gateway connects to the 10/100/1000BASE-T Ethernet port on your PC. To use the Ethernet interface, Ethernet cards available from your local PC or office supply retailer, or from your service provider. For best performance over an Ethernet connection, your PC should be equipped with a Gigabit Ethernet card.

After My Residential Gateway Is Connected, How Do I Access the Internet?

Your local service provider becomes your Internet Service Provider (ISP). They offer a wide range of services including e-mail, chat, news, and information services. Your service provider will provide the software you will need.

Can I Watch TV and Surf the Internet at the Same Time?

Absolutely! If you subscribe to cable television service, you can watch TV and use your Residential Gateway at the same time by connecting your TV and your Residential Gateway to the cable network using an optional cable signal splitter.

Can I Use my Existing Phone Number with the Residential Gateway?

Telephone numbers are portable in some areas. Contact your telephone service provider for more information about using an existing telephone number.

How Many Telephones Can I Connect?

The RJ-11 telephone-style connectors on the Residential Gateway can each provide telephone service to multiple telephones, fax machines, and analog modems. The maximum number of telephone devices connected to each RJ-11 port is limited by the total Ringing Load of the telephone devices that are connected. Many telephone devices are marked with a Ringer Equivalent Number (REN). Each telephone port on the Residential Gateway can support up to a 5 REN load. The sum of the REN load on all of the telephone devices attached to each port must not exceed 5 REN.

Common Troubleshooting Issues

This section describes common problems and offers solutions.

I don't understand the front panel status indicators

See *Operation of Front Panel Indicators* (on page 37), for more detailed information on front panel LED status indicator operation and function.

The Residential Gateway does not register an Ethernet connection

Try one of the following solutions:

- Verify that your computer has an Ethernet card and that the Ethernet driver software is properly installed. If you purchase and install an Ethernet card, follow the installation instructions very carefully.
- Verify the status of the front panel status indicator lights.

The Residential Gateway does not register an Ethernet connection after connecting to a hub

If you are connecting multiple PCs to the Residential Gateway, you should first connect the Residential Gateway to the uplink port of the hub using the correct crossover cable. The LINK LED of the hub will illuminate continuously.

The Residential Gateway does not register a cable connection

The Residential Gateway works with a standard, 75-ohm, RF coaxial cable. If you are using a different cable, your Residential Gateway will not function properly. Contact your service provider to determine whether you are using the correct cable.

There is no dial tone when I lift the handset

Try the following solutions if you cannot hear a dial tone:

- Your telephone wiring may be connected to the wrong RJ-11 port on the Residential Gateway. The Residential Gateway has two telephone ports. Verify that you are connected to the correct telephone port.
- There may be a problem with your telephone set. Use a different telephone set and listen to hear dial tone.

- There may be a problem with your home telephone wiring. Use a telephone and connect directly to the same RJ-11 port on the back of the unit. If the dial tone is working here but does not work at other locations in the home, a professional may need to diagnose and repair a problem with your telephone wiring.
- Verify that the telephone company has removed the previous telephone service from your home telephone wiring.
- Your telephone service may not be enabled from your cable telephony service provider. Contact your cable telephony service provider for more information.

Tips for Improved Performance

If your Residential Gateway does not perform as expected, the following tips may help. If you need further assistance, contact your service provider.

- Verify that the plug to your Residential Gateway AC power is properly inserted into an electrical outlet.
- Verify that your Residential Gateway AC power cord is not plugged into an electrical outlet that is controlled by a wall switch. If a wall switch controls the electrical outlet, make sure the switch is in the **ON** position.
- Verify that the **ONLINE** LED status indicator on the front panel of your Residential Gateway is illuminated.
- Verify that your cable service is active and that it supports two-way service.
- Verify that all cables are properly connected, and that you are using the correct cables.
- If you are using the Ethernet connection, verify that your TCP/IP is properly installed and configured.
- Verify that you have called your service provider and given them the serial number and MAC address of your Residential Gateway.
- If you are using a cable signal splitter so that you can connect the Residential Gateway to other devices, remove the splitter and reconnect the cables so that the Residential Gateway is connected directly to the cable input. If the Residential Gateway now functions properly, the cable signal splitter may be defective and may need to be replaced.
- If you are connected to your PC with an Ethernet connection, your PC should be equipped with a Gigabit Ethernet card for best performance.

7

Customer Information

If You Have Questions

If you have technical questions, call your service provider for assistance.



Americas Headquarters
Cisco Systems, Inc.
170 West Tasman Drive
San Jose, CA 95134-1706
USA

<http://www.cisco.com>
Tel: 408 526-4000
800 553-6387
Fax: 408 527-0883

This document includes various trademarks of Cisco Systems, Inc. Please see the Notices section of this document for a list of the Cisco Systems, Inc. trademarks used in this document.

Product and service availability are subject to change without notice.

© 2013, 2014 Cisco and/or its affiliates. All rights reserved.
November 2013

Part Number OL-29163-01